

500-HW Series

Hot Food Holding Drop-In Well



500-HWI



500-HW

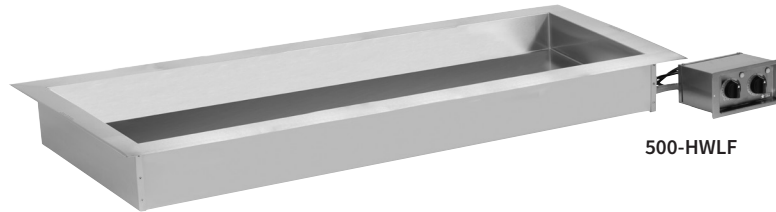

500-HWLF



• The gentle heating capability of Halo Heat significantly extends hot food holding life without continuing the cooking process.

- Provides a more appealing product with better appearance and fresher taste.
- Front-of-the-house use with an existing counter, overhead heating, and sneeze guard system or drop into a prep table for hot food plating convenience.
- Easy drop-in installation without the need of water or drainage connections and the related installation and water usage costs.
- Maintenance savings with the elimination of lime and scale buildup associated with steam table holding.
- Increase employee safety with the elimination of burning steam when changing pans.
- Adjustable thermostat with remote control suitable for mounting provides holding temperature flexibility without high steam table temperatures to scorch or burn.
- Stainless steel interior walls are easy to clean with coved corners on two sides of the well.
- HWI series with individual wells and independent controls expands your menu options.



CE EAC IP X3

ANSI/NSF 4

Short Form Spec

The Alto-Shaam 500-HW is a hot food holding well with a stainless steel exterior. The hot well includes stainless steel interior walls with coved corners on two sides. HW and HWLF models are controlled by two (2) adjustable thermostats with a range of 1 through 10, each with an indicator light. HWI and HWILF models are controlled by five (5) adjustable thermostats, one for each well, with a range of 1 through 10, each with an indicator light. The thermostat control is attached to the hot well base by two (2) 72" (1829mm) flexible and water tight conduits.

The hot well base is available in two depths. The 4-3/8" (111mm) deep hot well holds 4" (100mm) deep pans and the 6-3/8" (162mm) deep hot well holds 6" (150mm) deep pans. Both hot wells hold a combination of standard (gastronorm) pan sizes. The HW and HWLF hot wells includes ten (10) half-third-size pan divider bars and four (4) full-size pan divider bars. The HWI and HWILF hot wells includes ten (10) half-third-size pan divider bars.

- 500-HW/D4: 4-3/8" (111mm) depth, accepts five (5) full-size (gastronorm) pans
- 500-HW/D6: 6-3/8" (162mm) depth, accepts five (5) full-size (gastronorm) pans
- 500-HWLF/D4: 4-3/8" (111mm) depth, accepts five (5) full-size (gastronorm) pans
- 500-HWLF/D6: 6-3/8" (162mm) depth, accepts five (5) full-size (gastronorm) pans
- 500-HWI/D4: 4-3/8" (111mm) depth, accepts five (5) full-size (gastronorm) pans
- 500-HWI/D6: 6-3/8" (162mm) depth, accepts five (5) full-size (gastronorm) pans
- 500-HWILF/D4: 4-3/8" (111mm) depth, accepts five (5) full-size (gastronorm) pans
- 500-HWILF/D6: 6-3/8" (162mm) depth, accepts five (5) full-size (gastronorm) pans

Factory-installed Options

- Voltage Choices:
 - 120V
 - 208-240V
 - 230V
- Control Box Cord Location:
 - Back, Standard
 - Bottom, Option



W164 N9221 Water Street • P.O. Box 450 • Menomonee Falls, Wisconsin 53052-0450 • U.S.A.
 Phone: 262.251.3800 800.558.8744 U.S.A./CANADA Fax: 262.251.7067 800.329.8744 U.S.A. only
www.alto-shaam.com



500-HW Product/Pan Capacity*

D4: 120 lb (54 kg) MAX.	
MAX. VOLUME: D4: 72.5 qt (70 L)	
Full-Size Pans:	Five (5) 12" x 20" x 4" GN 1/1 (325mm x 530mm x 100mm)
Half-Size Pans:	Ten (10) 12" x 10" x 4" GN 1/2 (325mm x 265mm x 100mm)
Third-Size Pans:	Fifteen (15) 12" x 6" x 4" GN 1/3 (325mm x 176mm x 100mm)

*Based on 4" (100mm) deep pans. Will also accept 2-1/2" (65mm) deep pans; D6 hot wells will accept 6" (150mm) deep pans.

Installation Requirements

- Appliance must be installed level and must not be installed in any area where it may be directly affected by steam, grease, dripping water, high temperatures, or any other severely adverse conditions.
- Some foods may require additional overhead heating. Always monitor the food temperature and add overhead heating when needed.
- Countertop material must withstand temperatures up to 200°F (93°C).
- A stainless steel heat shield is recommended if the area under the appliance is used for storage.

Clearance Requirements

1" (25mm) from combustible surfaces

Accessories

- Pan Divider Bar — half-size/third-size 11318
- Pan Divider Bar — full-size 16019
- Locking Kit 5020849

500-HW Series Hot Food Holding Drop-In Well

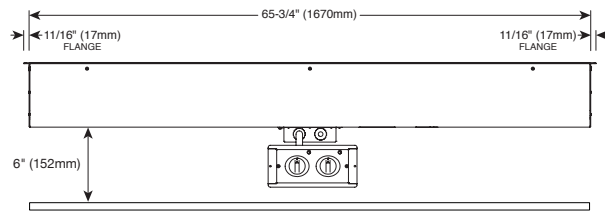
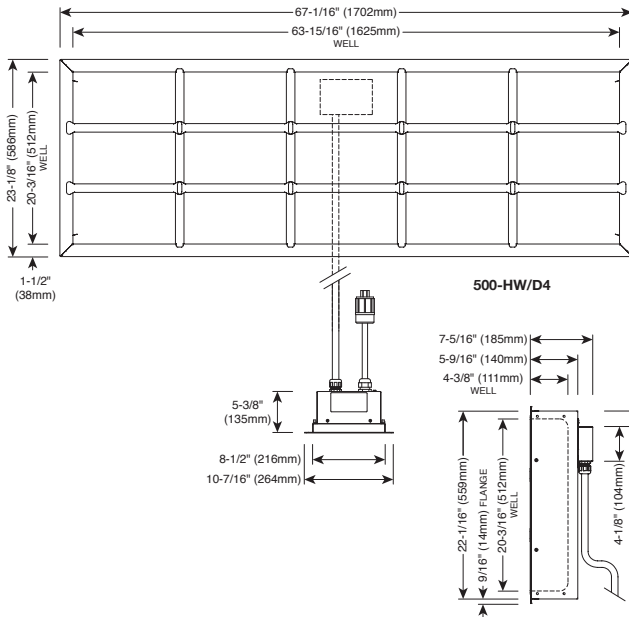

Optional stainless steel heat shield (not factory supplied)

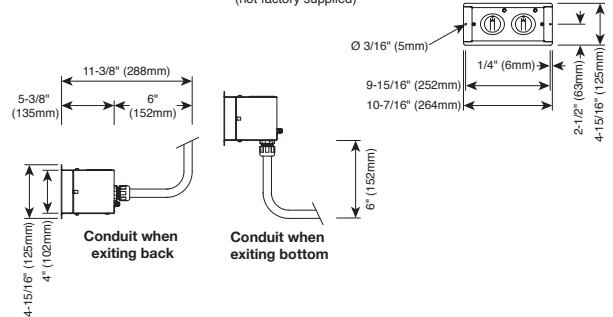

500-HWLF Series Hot Food Holding Drop-In Well

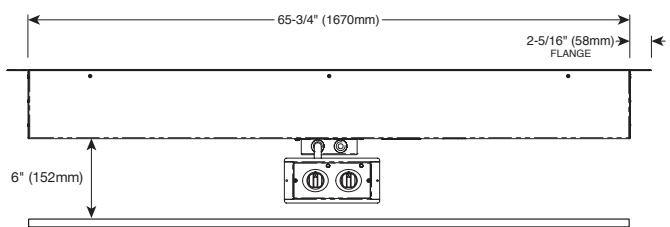
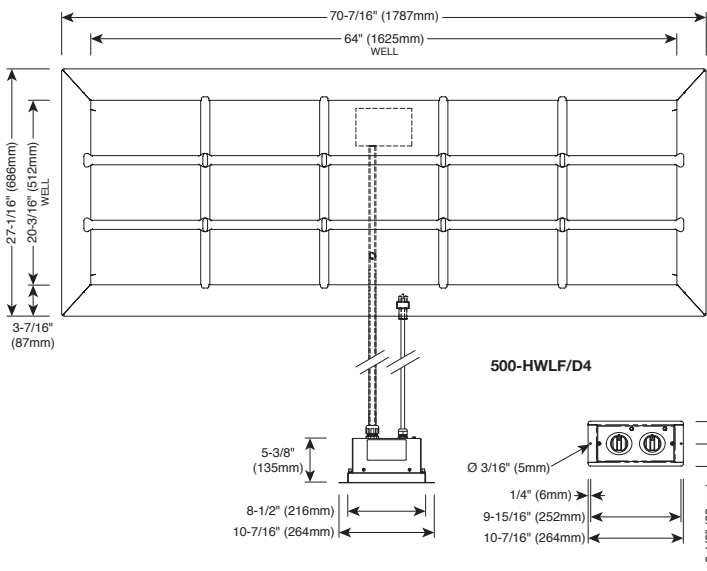

Optional stainless steel heat shield (not factory supplied)

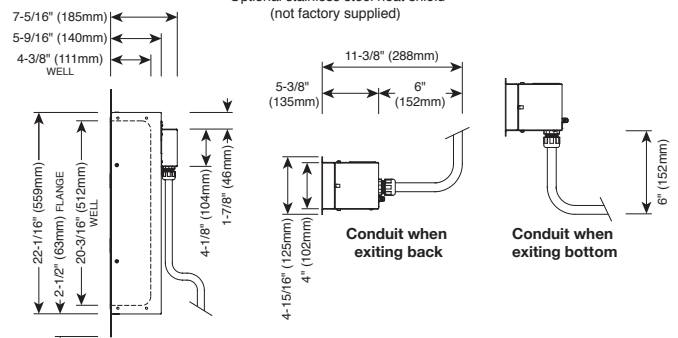

500-HWI Series

Hot Food Holding Drop-In Well

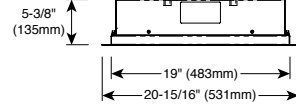
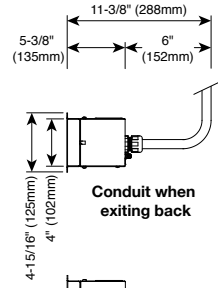
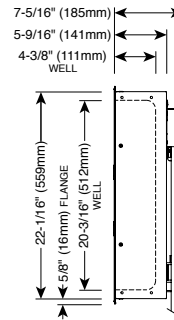
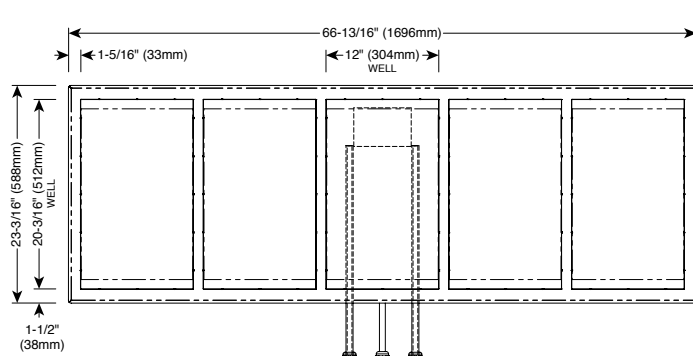

500-HWI/D4

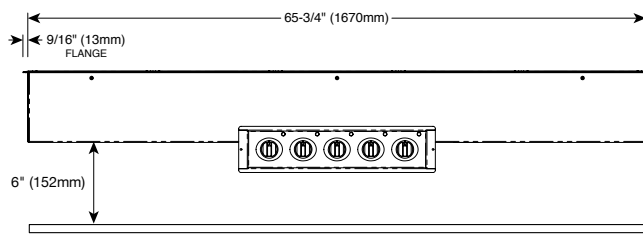
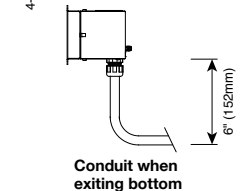
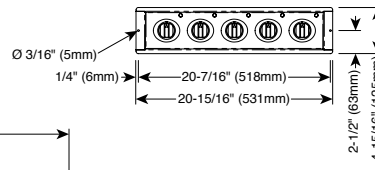

Optional stainless steel heat shield
(not factory supplied)

500-HWILF Series

Hot Food Holding Drop-In Well

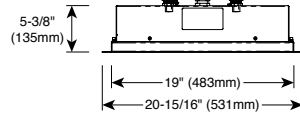
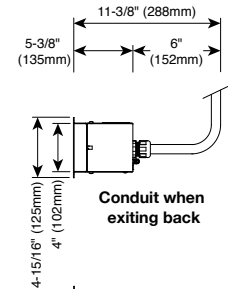
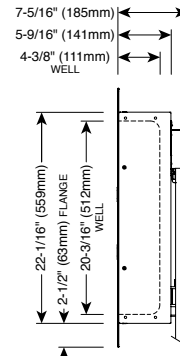
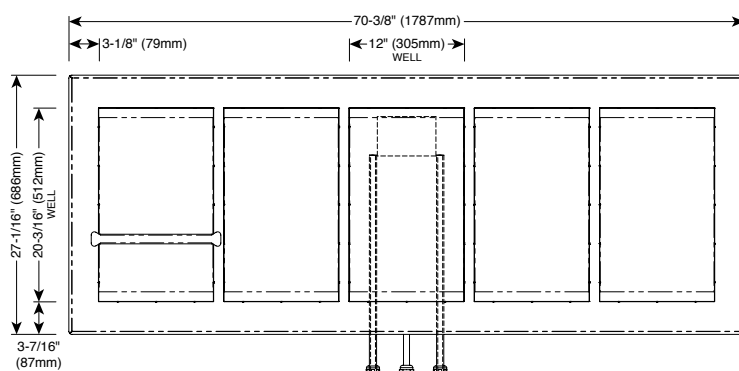



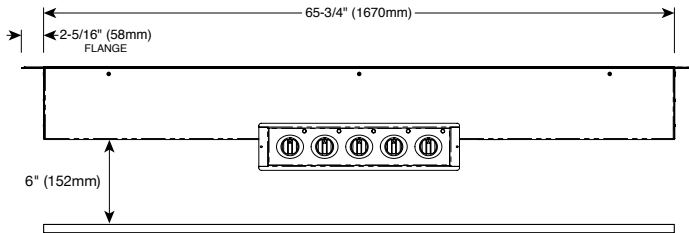
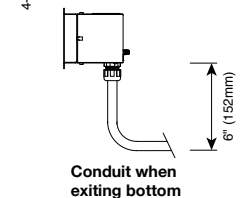
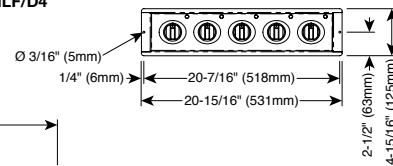

500-HWILF/D4



Optional stainless steel heat shield
(not factory supplied)



Electrical						
	V	Ph	Hz	A	kw	Plug configuration
500-HW/D4 and /D6 500-HWLF/D4 and /D6 500-HWI/D4 and /D6 500-HWILF/D4 and /D6	120	1	50/60	25.0	3.0	 NEMA L5-30P 30A - 125V plug
	208 - 240	1	50/60	10.8 - 12.5	2.3 - 3.0	 NEMA 6-15P 15A - 250V plug
	230	1	50/60	12.0	3.0	 CEE 7/7 Plug rated 250V  CH2-16P Plug rated 250V  BS1363 Plug rated 250V

Cord Length: 120V - 6 ft. (1.8m) 208-240V - 9 ft. (2.7m) 230V (CEE) - 9 ft. (2.7m) 230V (CH, BS) - 8 ft. (2.5m)

	Overall Exterior			Well Interior			Counter Cutout		Control Box Cutout*		
	Height	Width	Depth	Height	Width	Depth	Width	Depth	Height	Width	Depth
500-HW/D4	7-5/16" (185mm)	67-1/16" (1702mm)	23-1/8" (586mm)	4-3/8" (111mm)	63-15/16" (1625mm)	20-3/16" (512mm)	66-1/2" (1689mm)	22-1/2" (559mm)	4-1/4" (108mm)	8-3/4" (222mm)	11-3/8" (288mm)
500-HW/D6	9-5/16" (235mm)	67-1/16" (1702mm)	23-1/8" (586mm)	6-3/8" (162mm)	63-15/16" (1625mm)	20-3/16" (512mm)	66-1/2" (1689mm)	22-1/2" (559mm)	4-1/4" (108mm)	8-3/4" (222mm)	11-3/8" (288mm)
500-HWLF/D4	7-5/16" (185mm)	70-7/16" (1787mm)	27-1/16" (686mm)	4-3/8" (111mm)	64" (1625mm)	20-3/16" (512mm)	66-1/2" (1689mm)	22-1/2" (559mm)	4-1/4" (108mm)	8-3/4" (222mm)	11-3/8" (288mm)
500-HWLF/D6	9-5/16" (235mm)	70-7/16" (1787mm)	27-1/16" (686mm)	6-3/8" (162mm)	64" (1625mm)	20-3/16" (512mm)	66-1/2" (1689mm)	22-1/2" (559mm)	4-1/4" (108mm)	8-3/4" (222mm)	11-3/8" (288mm)
500-HWI/D4	7-5/16" (185mm)	66-13/16" (1696mm)	23-3/16" (588mm)	4-3/8" (111mm)	12" (304mm)	20-3/16" (512mm)	66-1/2" (1689mm)	22-1/2" (559mm)	4-1/4" (108mm)	19-1/4" (489mm)	11-3/8" (288mm)
500-HWI/D6	9-5/16" (236mm)	66-13/16" (1696mm)	23-3/16" (588mm)	6-3/8" (162mm)	12" (304mm)	20-3/16" (512mm)	66-1/2" (1689mm)	22-1/2" (559mm)	4-1/4" (108mm)	19-1/4" (489mm)	11-3/8" (288mm)
500-HWILF/D4	7-5/16" (185mm)	70-3/8" (1787mm)	27-1/16" (686mm)	4-3/8" (111mm)	12" (304mm)	20-3/16" (512mm)	66-1/2" (1689mm)	22-1/2" (559mm)	4-1/4" (108mm)	19-1/4" (489mm)	11-3/8" (288mm)
500-HWILF/D6	9-5/16" (238mm)	70-3/8" (1787mm)	27-1/16" (686mm)	6-3/8" (162mm)	12" (304mm)	20-3/16" (512mm)	66-1/2" (1689mm)	22-1/2" (559mm)	4-1/4" (108mm)	19-1/4" (489mm)	11-3/8" (288mm)

*Allow 6" (152mm) clearance from control box to conduit bend

Weight (est.)			
	Net Weight	Ship Weight*	Carton Dimensions* L X W X H
500-HW/D4	85 lb (39 kg)	125 lb (57 kg)	72" x 34" x 15" (1829mm x 864mm x 381mm)
500-HW/D6	94.5 lb (43 kg)	170 lb (77 kg)	72" x 34" x 15" (1829mm x 864mm x 381mm)
500-HWLF/D4	89.5 lb (41 kg)	220 lb (100 kg)	72" x 34" x 15" (1829mm x 864mm x 381mm)
500-HWLF/D6	100 lb (45 kg)	175 lb (79 kg)	72" x 34" x 15" (1829mm x 864mm x 381mm)
500-HWI/D4	107 lb (49 kg)	180 lb (82 kg)	72" x 34" x 15" (1829mm x 864mm x 381mm)
500-HWI/D6	121 lb (55 kg)	150 lb (68 kg)	72" x 34" x 15" (1829mm x 864mm x 381mm)
500-HWILF/D4	115 lb (52 kg)	contact factory	72" x 34" x 15" (1829mm x 864mm x 381mm)
500-HWILF/D6	128.5 lb (58 kg)	150 lb (68 kg)	72" x 34" x 15" (1829mm x 864mm x 381mm)

*Domestic ground shipping information. Contact factory for export weight and dimensions.

